



















40051



6028388

- | | | |
|---|---|--|
| 
6x
4121934 | 
8x
366021 | 
1x
370021 |
| 
8x
366521 | 
1x
302321 | 
6x
303921 |
| 
4x
300421 | 
1x
379421 | 
1x
623221 |
| 
4x
301021 | 
1x
302221 | 
2x
4188189 |
| 
5x
300921 | 
2x
306921 | 
2x
306821 |
| | | 
2x
407001 |

1



2



3



4

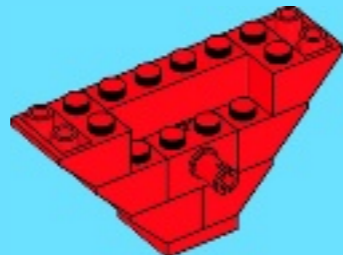

5

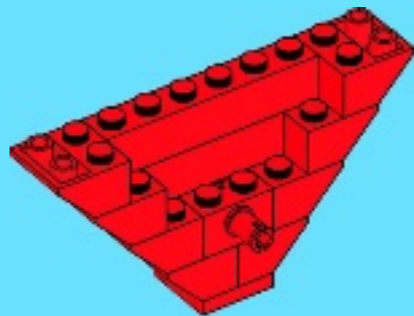

6

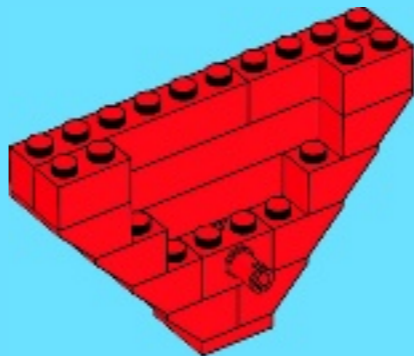

7

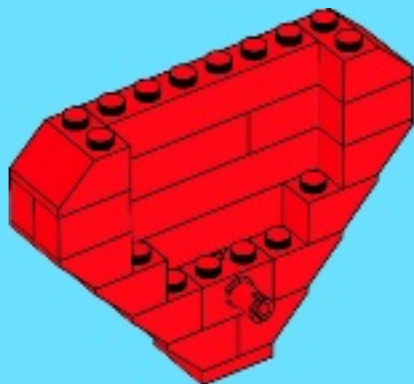

8

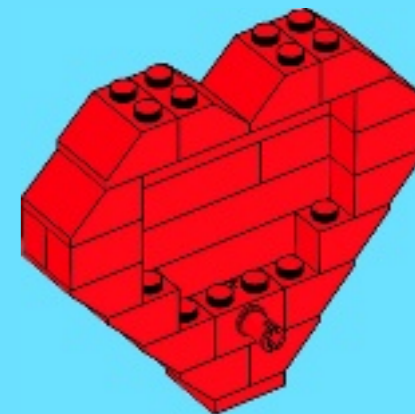

9

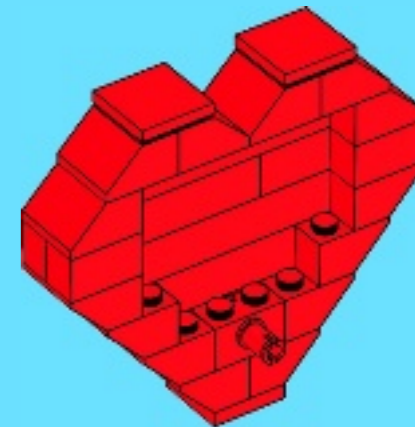



1



2

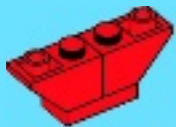

3

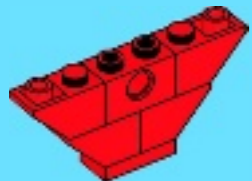

4

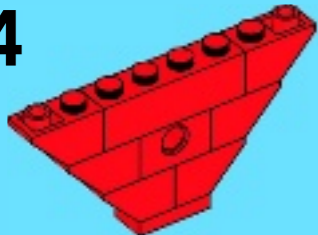

5

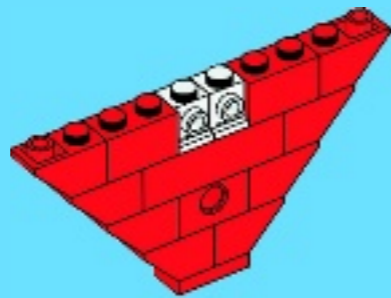

6

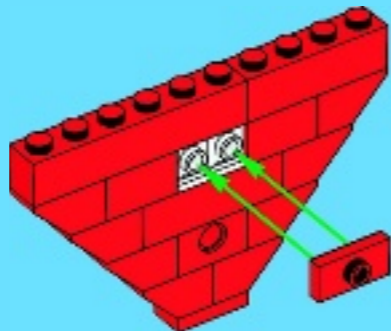

7

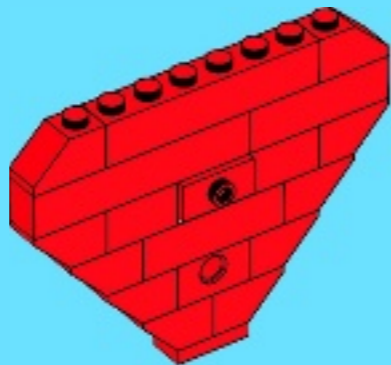

8

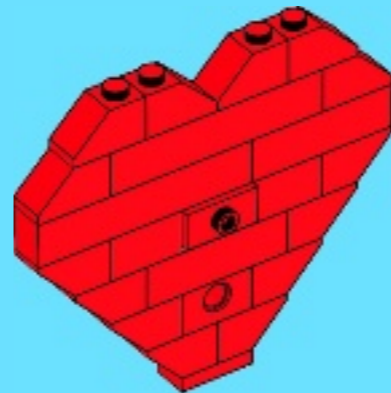

9

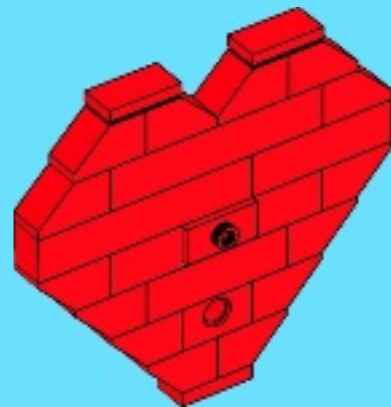

10

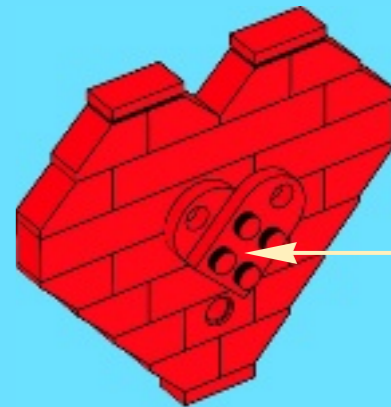

11

